



IJITCE

ISSN 2347- 3657

International Journal of Information Technology & Computer Engineering

www.ijitce.com



Email : ijitce.editor@gmail.com or editor@ijitce.com

COMPARATIVE ANALYSIS OF SELECTIVE HARMONIC ELIMINATION OF MULTILEVEL INVERTER USING GENETIC ALGORITHM

Mrs. A. Baranishri, Mrs. D. HemaMalini, Mrs. K. Lavanya, Dr. J. Thilagavathi
Professor ⁴ Assistant Professor ^{1,2,3}

baranishri.a@actechnology.in, hemamalini.d@actechnology.in, klavanya@actechnology.in,
thilagavathi@actechnology.in

Department of AI & DS, Arjun College of Technology, Thamaraikulam, Coimbatore-Pollachi Highway,
Coimbatore, Tamilnadu-642 120

Abstract

An inverter with a cascaded multilevel voltage source that eliminates harmonics is the subject of this article. Here, picking the right switching angles to remove certain harmonics is the main idea. The optimal switching angles for reducing THD and eliminating selected lower-order harmonics with fundamental components at the appropriate levels are achieved in this study using the Genetic Algorithm (GA) optimisation approach. To illustrate the method's efficacy, we run simulations on an inverter with seventeen and fifteen levels to find the optimal switching angles for reducing total harmonic distortion (THD) and eliminating low-order harmonics. In terms of taking THD into account, comparisons have been made between seventeen and fifteen levels.

key-words:- Genetic Algorithm, Multilevel Inverter, Selective Harmonic Elimination (SHE), Three Phase Cascade H-Bridge Inverter, , Total Harmonic Distortion (%THD).

1. Introduction

The multilevel inverter has recently become an integral part of many industrial applications, including static power conversion for high power applications, field-effect transistors (FACTS) devices, high voltage direct current (HVDC), and electric drives for all ac motors when a dc supply is used. Their reduced switching losses and increased voltage capabilities are two additional benefits of using them instead of conventional inverters. A few examples of popular multi-level topologies are the cascaded H-bridge, diode-clamped, and flying capacitor inverters. In comparison to other multi-level topologies, the cascading H-bridge multi-level inverter is simpler and uses fewer components. Furthermore, adding more output voltage levels is a breeze and doesn't need a more complicated power circuit. The primary goal of using multiple inverters is to enhance output quality while decreasing harmonics. The required output voltage is achieved by controlling and determining the switching angles using various switching algorithms, including pulse width modulation (PWM), space vector modulation (SVM), Sinusoidal pulse width modulation (SPWM), and the removal of certain harmonics. In this work, we solve the non-linear equation of a multilevel inverter with the goal of eliminating certain harmonics. The Newton-Raphson algorithm is one of the proposed algorithms for this exact reason. Although this approach is quick and accurate, it is not applicable to all modulation indices and relies on initial guesses, which may be avoided by using a genetic algorithm. A Genetic Algorithm (GA) optimal switching for a multilayer inverter is presented in this work. Cascaded multilevel inverters employ the computed switching angles to activate their switching devices. A comparison of a seventeen-level inverter and a fifteen-level inverter using the GA technique has led to the exploration of novel methods. The results of the simulation demonstrated that an inverter with seventeen levels is more efficient than one with fifteen levels.

2. Cascaded H Bridge Multilevel Inverter

In this paper a three phases cascaded H bridge multilevel inverter is consider. The cascaded multilevel inverter consists of a number of H-bridge inverter units with separated dc source for each unit and it connected with series or cascade as shown in Fig. 1.

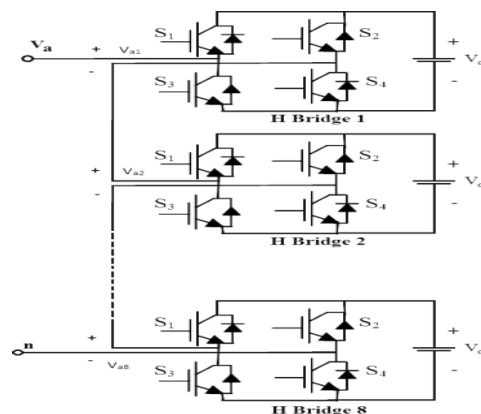

Fig.1 Cascaded multilevel inverter(Eight bridge)

For fifteen level, it has seven DC source is connected in series and for seventeen level, it has Eight DC source. Each separated DC sources is connected to H-bridge inverter and can produce voltages of $+V_{dc}$, 0 $-V_{dc}$ by different combination of four switches (S_1, S_2, S_3 and S_4). Where V_{dc} is the voltage of its DC bus. Each inverter generates quasi-square wave voltage waveform with different duty cycle ratios, which together form the staircase output voltage waveform as shown in fig 2. The number of output phase voltage levels in a cascade multilevel inverter is then $2s+1$, where s is the number of isolated dc sources. The ac voltage produced from these dc voltages approaches a sinusoidal.



Fig.2 switching angle of multilevel inverter

In fig 2 shown the output voltage waveform $V(t)$ of multilevel inverter. The voltage waveform can express in Fourier series as

$$V(t) = \sum_{n=1}^{\infty} (a_n \cos n\omega t + b_n \sin n\omega t) \quad (1)$$

Due odd quarter wave symmetry of the output voltage waveform the even harmonics are absent ($a_n = 0$) and only odd harmonics are present. The amplitude of the n^{th} harmonic can be expressed with the first quadrant switching angles i.e. $\alpha_1, \alpha_2, \dots, \alpha_m$ as follows:

$$b_n = (4V_{dc}/n\pi) \sum_{n=1}^{\infty} \sin \omega t \quad (2)$$

and,

$$0 < \alpha_1 < \alpha_2 < \dots < \alpha_m < \frac{\pi}{2} \quad (3)$$

3. Selected Harmonic Elimination of Cascaded H Bridge Inverter

In case of SHE, selected lower order harmonics are eliminated while remaining harmonic components are reduced to minimize THD. In this paper lower order harmonics i.e. i.e 5th, 7th, 11th, 13th are eliminated. The expression desire fundamental voltage b_1 in equation (1). Moreover, the relation between the fundamental and the maximum obtainable voltages is given by modulation index (M) is defined as the ratio of the fundamental output voltage V_1 to the maximum obtainable fundamental voltage V_{1max} . The maximum fundamental voltage is obtained when all the switching angles are zero i.e.

$$V_{1max} = 4V_{dc}/\pi,$$

Therefore the expression for M

$$M = \pi V_1 / 4V_{dc} \quad (0 \leq M \leq 1) \quad (4)$$

Mathematically SHE problem can be formulated as:

$$\begin{aligned} \cos(\alpha_1) + \cos(\alpha_2) + \dots + \cos(\alpha_m) &= mM \\ \cos(5\alpha_1) + \cos(5\alpha_2) + \dots + \cos(5\alpha_m) &= 0 \\ \cos(7\alpha_1) + \cos(7\alpha_2) + \dots + \cos(7\alpha_m) &= 0 \\ \cos(11\alpha_1) + \cos(11\alpha_2) + \dots + \cos(11\alpha_m) &= 0 \\ \cos(13\alpha_1) + \cos(13\alpha_2) + \dots + \cos(13\alpha_m) &= 0 \\ &\vdots \\ \cos(n\alpha_1) + \cos(n\alpha_2) + \dots + \cos(n\alpha_m) &= 0 \end{aligned} \quad (5)$$

The equation (5) is a system of transcendental equation, known as selective harmonic elimination (SHE) equation. From the equation unknown switching angle $\alpha_1, \alpha_2, \alpha_3, \alpha_4, \alpha_5, \alpha_6, \alpha_7, \dots, \alpha_m$ are calculated by the Genetic Algorithm (GA) with the help of the given value of M (from 0 to 1) for trigger semiconductor switches. m is no of h bridge per phase .

4. Genetic Algorithm

Genetic Algorithms (GAs) are a computational adaptive heuristic search algorithm based on the evolutionary ideas of natural selection and genetics. GAs is inspired by Darwin's theory about - "Survival of Fittest". It follows biological evolution by using genetic operators referred to as chromosome, selection, crossover and mutation. As a process of optimization it provides the optimal system performance.

4.1 Chromosome

In GA, chromosome means the feasible solution for the problem, for multilevel inverter, the number of variables are the number of controllable switching angles.

4.2 Selection

Selection is the stage of a genetic algorithm in which individual genomes are chosen from a population for later breeding. The selection operator determines how the parents are chosen to create the offspring.

4.3 Crossover

After the reproduction phase is over, the population is enriched with better individuals. Reproduction makes clone of good strings, but does not create new ones. Crossover operation is applied to the meeting pool with a hope that it would create a better string. Crossover is the most significant operation in GA.

4.4 Mutation

Mutation is another vital operation. It works after crossover operation. Mutation means that the element of DNA is modified. This change is mainly caused by error in copying gens from parents. This process is repeated, until the preferred optimum of the objective function is reached.

4.5 Evaluation of fitness function:

The fitness function plays a very important role in guiding GA to obtain the best solutions within a large search space. The objective of this paper is to minimize lower order harmonics (5th, 7th, 11th, and 13th) and reduce the THD. Therefore the fitness function has to be associated to THD. The fitness function formulated as.

$$FV = \frac{\sqrt{\sum_{n=5,7,11,13} \left(\frac{1}{n} \sum_{k=1}^5 \cos(n\alpha_k) \right)^2}}{\sum_{k=1}^5 \cos\alpha_k}$$

To find the desire value GA need to run for a certain number of iterations (1000 in this case). After the first iteration, fitness values are used to determine new offspring. These go through crossover and mutation operations and a new population is created which goes through the same cycle starting from evaluation. After these iterations, the GA finds one solution. The flow chart showed in Fig.3

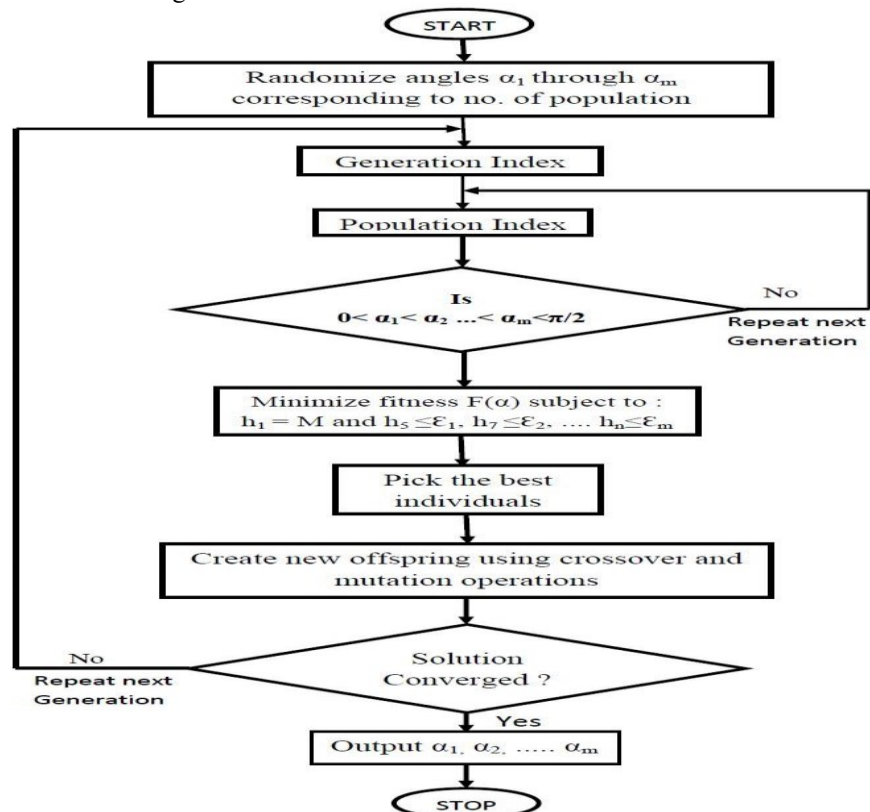

Fig.3 Flowchart of Genetic algorithm

5. Simulation Results

In this section the proposed technique is implemented on three phase fifteen level and seventeen level cascaded multilevel inverter Genetic Algorithm is use to calculate the switching angles. Three phase fifteen level and seventeen level cascaded H-bridge multilevel inverter are developed in MATLAB Simulink and the calculated switching angles are used to trigger the GTO switching devices. The offline computed switching angles for fifteen level and seventeen level cascaded multilevel inverter are shown in Table I and Table II.

TABLE I: Switching angles at various modulation Index (M) of 15 level inverter

M	α_1	α_2	α_3	α_4	α_5	α_6	α_7
0.1	0.612	0.789	0.977	1.137	1.355	1.562	1.563
0.2	0.617	0.785	0.974	1.132	1.35	1.458	1.564
0.3	0.609	0.781	0.971	1.123	1.342	1.459	1.562
0.4	0.318	0.592	0.893	1.025	1.17	1.457	1.562
0.5	0.35	0.577	0.849	0.962	1.079	1.214	1.554
0.6	0.103	0.528	0.675	0.808	1.033	1.208	1.476
0.7	0.093	0.314	0.483	0.65	0.856	1.029	1.222
0.8	0.079	0.295	0.462	0.626	0.851	1.002	1.184
0.9	0.04	0.125	0.179	0.314	0.436	0.566	0.736
1.0	0.02	0.125	0.177	0.3	0.427	0.555	0.716

The variation of switching angles with modulation indices is plotted in fig 4.

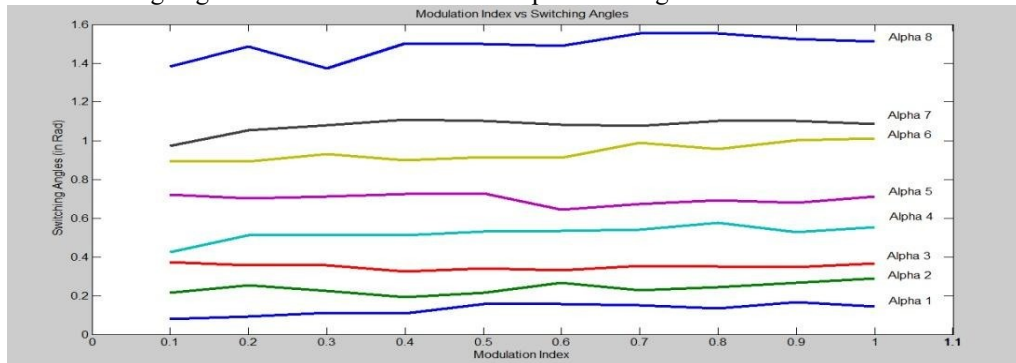

Fig. 4. Modulation Index vs. Calculated switching for 15 level

TABLE II: Switching angles at various modulation Index (M) of 17 level inverter

M	α_1	α_2	α_3	α_4	α_5	α_6	α_7	α_8
0.1	0.116	0.576	0.692	0.822	1.05	1.366	1.555	1.556
0.2	0.612	0.780	0.969	1.124	1.351	1.564	1.564	1.564
0.3	0.594	0.729	0.892	1.025	1.172	1.373	1.56	1.56
0.4	0.283	0.574	0.654	0.885	0.989	1.072	1.168	1.494
0.5	0.084	0.315	0.562	0.651	0.853	1.025	1.223	1.527
0.6	0.090	0.554	0.654	0.756	0.874	1.055	1.272	1.436
0.7	0.087	0.487	0.652	0.749	0.856	1.034	1.244	1.385
0.8	0.027	0.118	0.334	0.449	0.584	0.767	0.876	1.262
0.9	0.063	0.245	0.347	0.479	0.624	0.852	0.979	1.162
1.0	0.065	0.070	0.169	0.259	0.378	0.467	0.594	0.764

The variation of switching angles with modulation indices is plotted in fig 5.

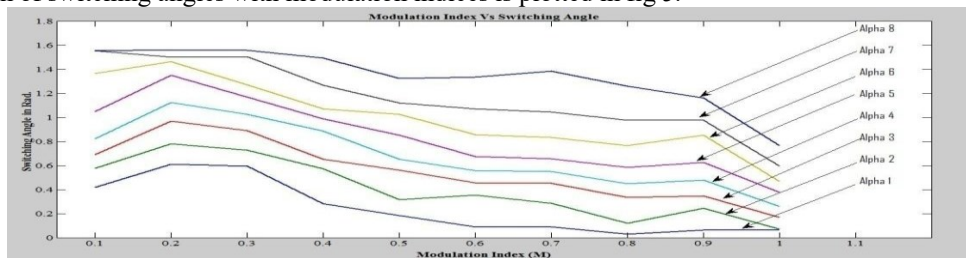

Fig. 5. Modulation Index vs. Calculated switching for seventeen level

Simulation results for a fifteen-level cascaded h bridge multilevel inverter operating with equal DC sources (25 volt per h bridge) are shown in fig. 6 with the voltage values indicated. Because of Modulation index 0.8 the output voltage is approximate $(175 \times 0.8) = 140$ V.

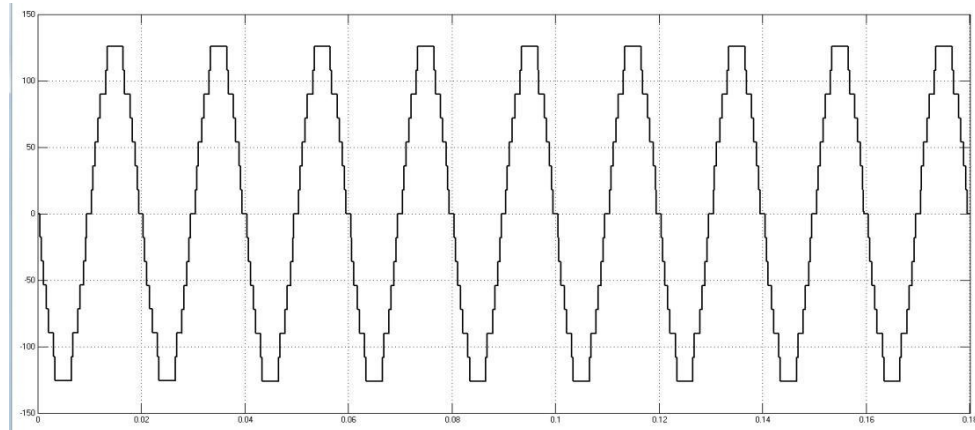

Fig. 6. Simulated per phase output voltage for a fifteen-level cascaded h bridge multilevel inverter for the Modulation Index 0.8

The frequency spectrum for the steady voltage waveform of the simulation result is shown in Fig. 7. Where it can be noticed that the target harmonics are minimized with a THD of 1.60%. 5th and 7th harmonic was minimized less than 0.8%, 11th and 13th harmonics was minimized less than 1%.

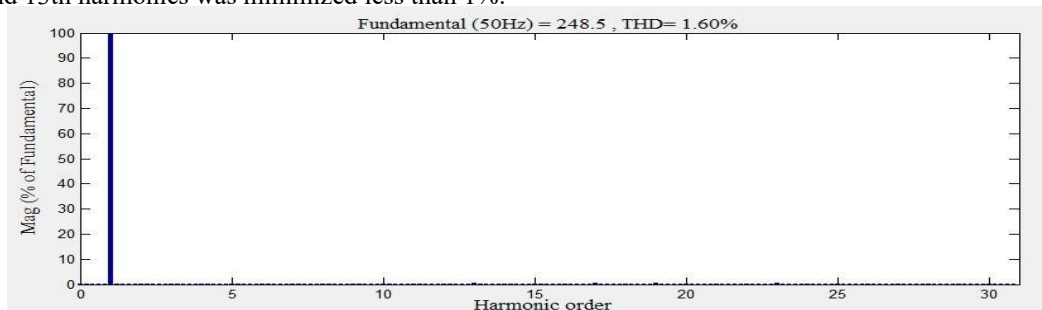

Fig. 7. Frequency spectrum for Output Line-Line Voltage

Similarly, simulation results for a seventeen-level cascaded h bridge multilevel inverter operating with equal DC sources (25 volt per h bridge) are shown in fig. 8 with the voltage values indicated. Because of Modulation index 0.8 the output voltage is approximate $(200 \times 0.8) = 160V$

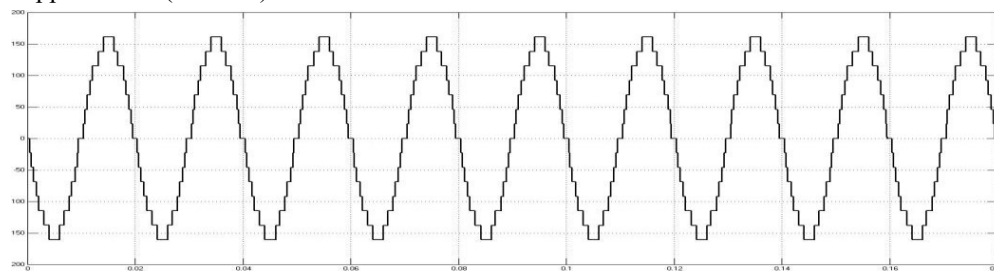

Fig. 8. Simulated per phase output voltage for a seventeen-level cascaded h bridge multilevel inverter for the Modulation Index 0.8

The frequency spectrum for the steady voltage waveform of the simulation result is shown in Fig. 9. Where it can be noticed that the target harmonics are minimized with a THD of 0.79%. 5th and 7th harmonic was minimized less than 0.2%, 11th and 13th harmonics was minimized less than 0.6%.

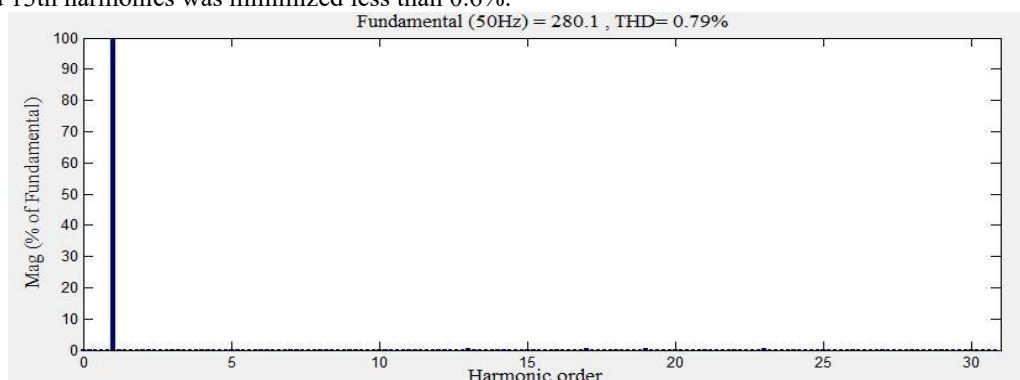

Fig. 9. Frequency spectrum for Output Line-Line Voltage

A comparative study of simulated THD for the modulation indices 0.1 to 1.0 for three phase fifteen level and seventeen level cascaded multilevel inverter are shown in Table III. The variation is shown in fig. 10

TABLE III: THD (%) of fifteen level and seventeen level cascaded multilevel inverter

Modulation Index	THD (%) for fifteen level	THD (%) for seventeen level
0.1	4.26	3.56
0.2	3.59	2.59
0.3	2.83	1.93
0.4	2.67	1.47
0.5	2.16	1.06
0.6	2.21	1.21
0.7	1.65	0.95
0.8	1.60	0.79
0.9	1.92	0.92
1.0	2.02	1.02

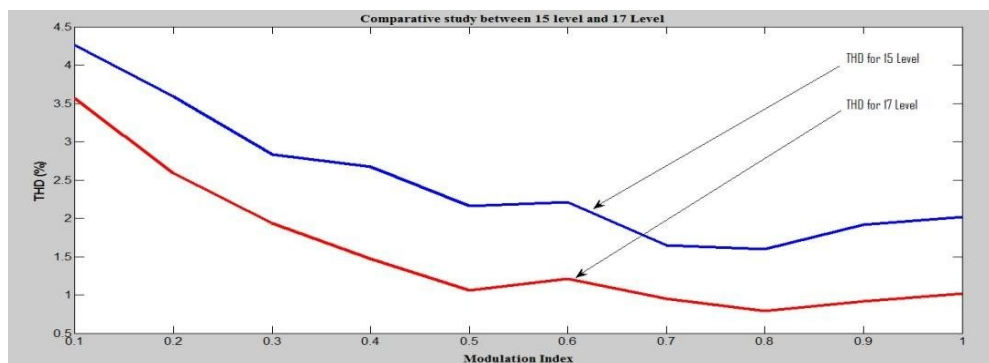

Fig. 10. Comparative study between fifteen level and seventeen level cascaded multilevel inverter

6. Conclusion

The paper demonstrates that the selective harmonics elimination problem in multilevel inverter by using GA successfully. The validation of genetic algorithm for the estimation of optimum switching angles of staircase waveform generated by multilevel inverters, and Comparison has been done between the 15-level and 17-level with respect to the consideration of THD.

It is found that the harmonic content present in waveform produced by cascaded H-bridge multilevel inverter is lowest. Also, the waveform produced by the cascaded H-bridge multilevel inverter approximate sinusoidal shape better than the other types of multilevel inverters. And the amount of harmonics in the waveform produced decreases with increase in the level of multilevel inverter. However, the decrease in the harmonics is at the cost of increase in the components used, that is increase in cost. The simulated results also can be validate through suitable experiments.

References

- B. Ozpineci, L. M. Tolbert, and J. N. Chiasson, "Harmonic optimization of multi-level converters using genetic algorithms," Proceeding on 35th IEEE Power Electronics Specialists Conference, vol. 5, pp. 3911 -- 3916, 2005.
- Chiranjit Sarkar, Soumyasanta Saha, Pradip Kumar Saha, Goutam Kumar Panda. " Selective Harmonics Elimination Of Cascaded Multilevel Inverter Using Genetic Algorithm", IJARECE, PP- 935-939, Volume 2, Issue 12, December- 2013
- F. Z. Peng, "A generalized multilevel inverter topology with self voltage balancing", IEEE Trans. Ind. Applicant., vol. 37, pp. 611-618, Apr. 2001.
- Goldberg D.E. (1989). Genetic Algorithm in Search, Optimization and Machine Learning, MA: Addison Wesley
- Giuseppe Carrara, Simone Gardella, Mario Marchesoni, Raffaele Salutari, and Giuseppe Sciuotto, 'A New Multilevel PWM Method: A Theoretical Analysis', IEEE Trans. on Ind. power Electronics, JULY 1992, VOL. 7, NO. 3,
- Jason Lai, Chair Dusan Borojevic Alex Q. Huang, "Optimized harmonic stepped waveform for multi-level inverters", M.s.c thesis, Virginia Polytechnic Institute and State University, 1999.
- J. Rodriguez, J. S. Lai, and F. Z. Peng, "Multilevel inverters: A survey of topologies, controls, and applications," IEEE Trans. on Industrial Electronics, vol. 49, no. 4, pp. 724-738, Aug. 2002.
- John Chiasson, Leon Ad. Tolbert, Keith McKenzie and Zhong Du 'Elimination of Harmonics in a Multilevel Converter using the Theory of Symmetric Polynomials and Resultants' Proceedings of the 42nd IEEE Conference on Decision and Control Maui, Hawaii USA, pp.3507-3512, December 2003
- L. Chambers.(1995) "Practical handbook of genetic algorithms"(Boca Raton, CRC Press.)
- M. D. Manjrekar, P. K. Steimer, and T. A. Lipo, "Hybrid multilevel power conversion system: a competitive solution for high-power applications," IEEE Trans. Ind. Applicat., vol. 36, pp. 834-841, June 2000.
- M. G. Hosseini Aghdam, A. Ghasemi, J. Milimonfared, S. H. Fathi, and M. Arehpanahi, "Speed control of induction motor by multicarrier PWM multilevel inverter", The 40th International Universities Power Engineering Conf. (UPEC 2005), Cork, Ireland, Sept. 2005.
- Mihammad H. Rashid, 'Power Electronics Circuit, Devices and Application' (Pearson Education, Inc. 2012, PP - 409-419)
- Sirisukprasert S, "Optimized harmonic stepped-waveform for multilevel inverter" M.Sc. Thesis, Department of Electrical and

Computer Engineering, Virginia Polytechnic Institute and State University (Virginia Tech), Sept. 1999.

S. M. Sadat Kiaee, A. Namadmalan, J. Shokrollahi Moghani, 'A New Reliability Evaluation Technique for MultiLevel Inverters', IEEE Trans. Ind. Appl, 2013, pp- 361-366.